

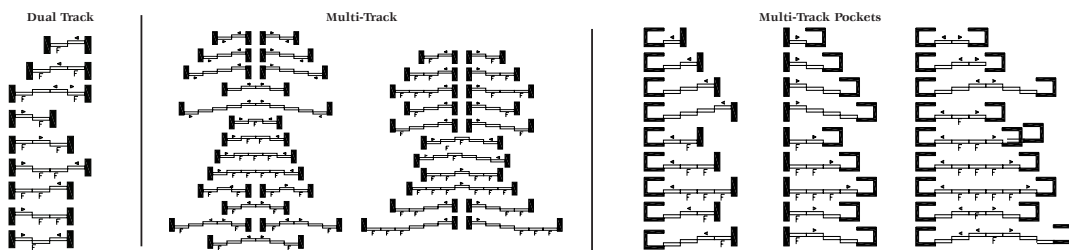

SI1100 series aluminum framed mesh insect screen. Extruded aluminum frame with fiber glass corners for added strength. Multiple operation types for commercial and residential applications.

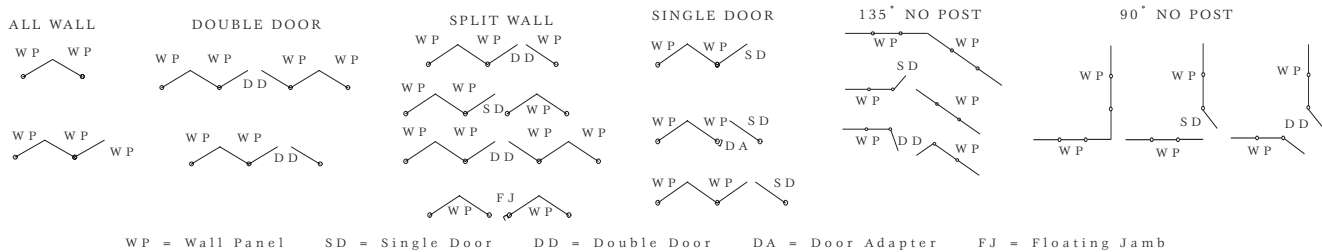

## Features:

- Operations: folding, swing, sliding (multi-track)
- Maximum panel size
  - Folding 4' x 10'
  - Sliding 6' x 12' (with mullion support)
- Folding Glass Wall hinges
- Standard Finishes
  - Duracron: Hartford Green, Bronze, Black, Natural Clay, White, Sandstone
- Mesh insect screen material, pet screen options

## Options:

- Oversized panels upon request
- Custom finishes
  - Class I anodized: Dark Bronze, Clear
  - Powder coat finish: AAMA 2604-05
  - Fluoropolymer: 50% or 70%
  - Cladding options
  - Dual color or dual finish options
- Drain sills available
- Folding screens with integrated swing doors



SI1101 • SI1102 • SI1103

Folding Screen

1 1/4"

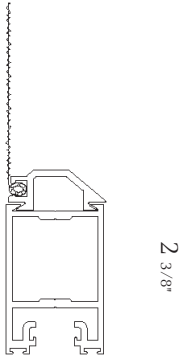

Standard Sliding Screen

1 1/4"

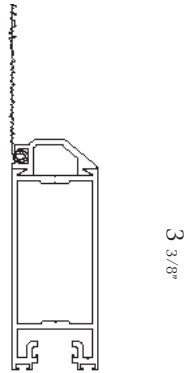

Single Door

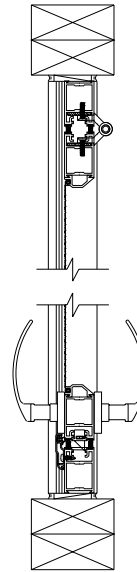

Swing Door

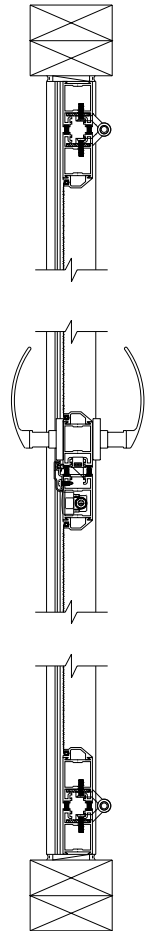

Head and Sill



Head and Sill

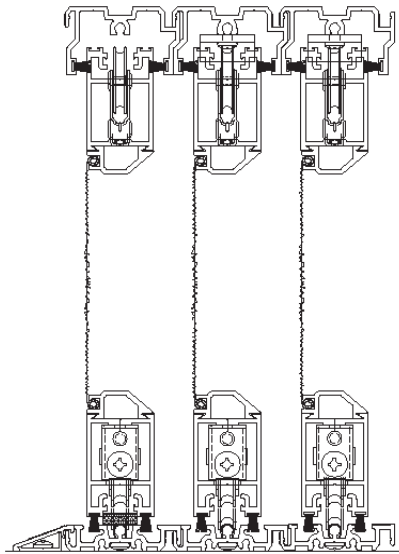

Jamb

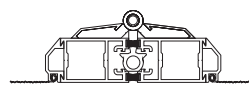
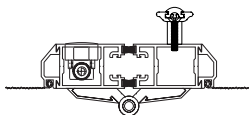
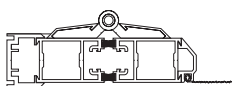

Jamb

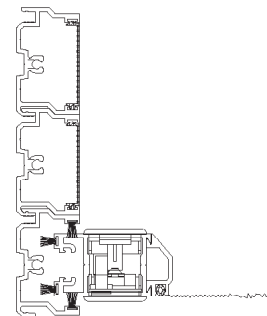

Please be sure to visit our website for additional product information.  
[www.solarinnovations.com](http://www.solarinnovations.com)

